

TOSHIBA



40L1863DB

QUICK START GUIDE

Please visit www.toshiba-tv.com to download the full user manual.

1 Building and fitting stand

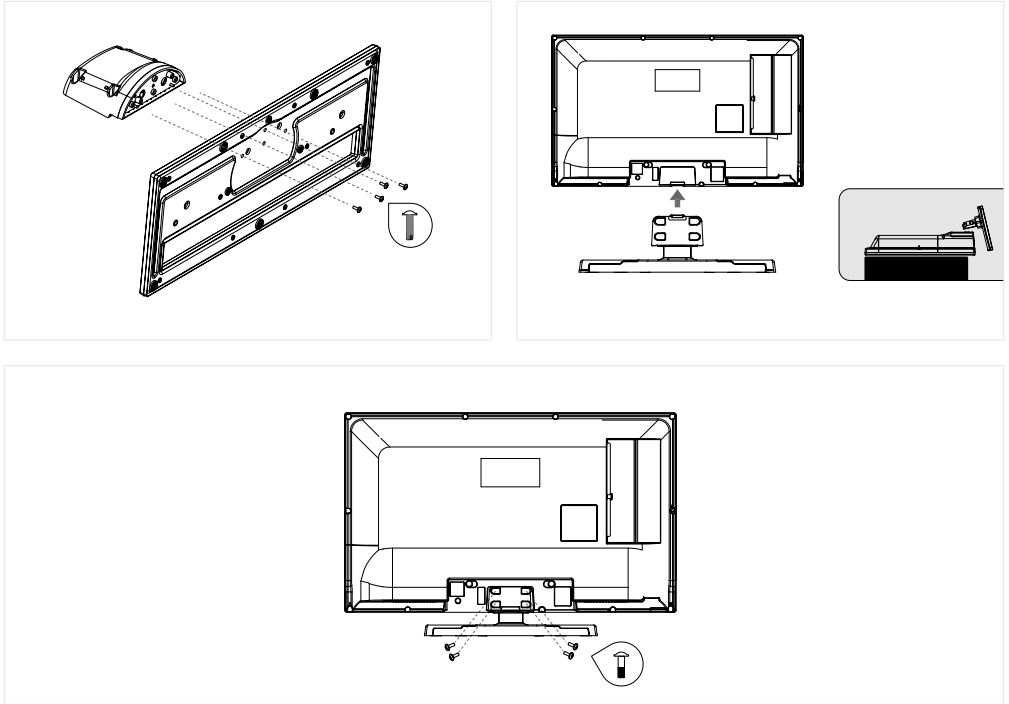

2 Inserting the batteries into the remote

Remove the back cover to reveal the battery compartment. Insert two size **AAA** batteries. Make sure the (+) and (-) signs match (observe correct polarity). Do not mix old and new batteries. Replace only with same or equivalent type. Place the cover back on. A message will be displayed on the screen when the batteries are low and must be replaced. Note that when the batteries are low, the performance of the remote control may be impaired.

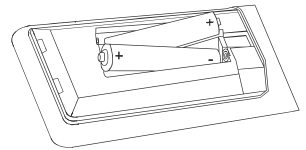

3 Connections

Antenna

Connect the antenna cable/s to your TV.

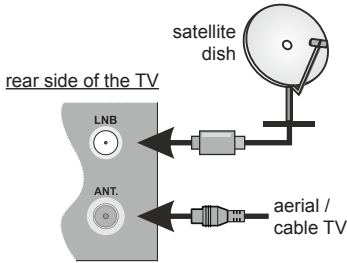

External Devices



PLEASE ENSURE BOTH UNITS ARE SWITCHED OFF BEFORE CONNECTING

Use the proper cable to connect two units together. To select the desired input source, press the **Source** button on the remote control. Or press the switch in consecutively until the **Sources list** is displayed.

HDMI connection

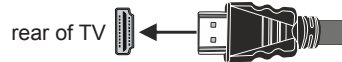

Power

After unpacking, allow the TV set to reach the ambient room temperature before you connect the set to the mains. Plug the power cable to the mains socket outlet.

Plug the power cable to the mains socket whilst in 'off' position, and then turn the mains socket on.

IMPORTANT: The TV set is designed to operate on a **220-240V AC, 50 Hz** supply.

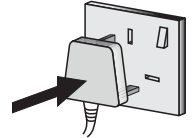

4 Switching on the TV

In order to turn the TV on from standby mode:

- Press the **Standby** button, a numeric button or **Programme +/-** button on the remote control
- Press the centre of the control switch inwards, located at the rear left hand side of the TV

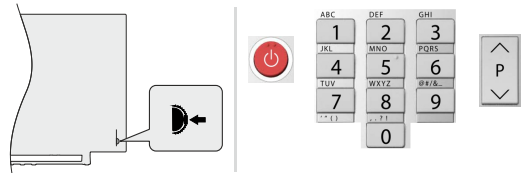

5 Internet connection

You can set up your TV so that it can access FreeviewHD services (optional) through your local area network (LAN) using a wired connection.

Wired

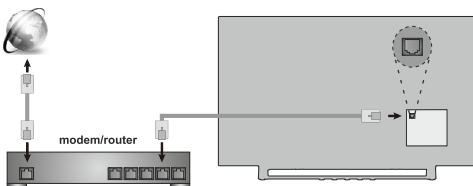

Note: The figures are for representation only

6 Remote control

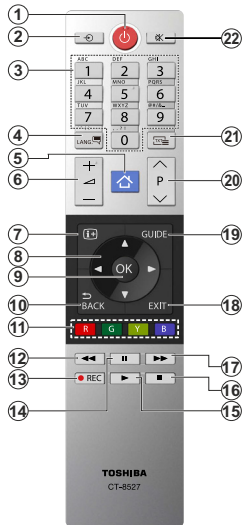

1. Standby
2. Source
3. Numeric buttons
4. Language
5. Menu
6. Volume +/-
7. Info
8. Directional buttons
9. OK
10. Back/Return
11. Coloured buttons
12. Rewind
13. Record
14. Pause
15. Play
16. Stop
17. Fast forward
18. Exit
19. Guide
20. Programme +/-
21. Text
22. Mute

7 First time installation

When turned on for the first time, the TV's welcome screen will be displayed. Select your language and press **OK**. Follow the on screen instructions to set your TV and install channels. The installation wizard will guide you through the setup process. You can perform **First Time Installation** anytime using the related option in the **Settings>Installation** menu.

8 Accessing the full user manual

You can review your TV user manual online or download as you like. Scan this QR code or visit <https://toshiba-tv.com/uk-uk/support>



Accessories Included

- Remote Control
- Batteries: 2 x AAA
- Quick Start Guide
- Side AV Connection Cable

Feature Overview

Media Browser

Browse the media content stored on USB devices that are connected to your TV

Common Interface

Decode encrypted digital TV channels with a Conditional Access Module(CAM) and a card provided by a digital TV service operator

USB Recording

Record your favourite TV programmes

Electronic Programme Guide

Display the scheduled digital TV programmes

CEC

Control basic functions of the connected HDMI-CEC compatible audio/video devices with the remote control of the TV

Some features may not be available dependant on your TV model, please check the product fiche for your product specifications

For more detailed information on installation, function and control refer to the full manual on our the website at <http://www.toshiba-tv.com/uk-uk/support>

Safety Information



CAUTION

RISK OF ELECTRIC SHOCK
DO NOT OPEN



CAUTION: TO REDUCE THE RISK OF ELECTRIC SHOCK DO NOT REMOVE COVER (OR BACK). NO USER-SERVICEABLE PARTS INSIDE. REFER SERVICING TO QUALIFIED SERVICE PERSONNEL.

In extreme weather (storms, lightning) and long inactivity periods (going on holiday) disconnect the TV set from the mains.

The mains plug is used to disconnect TV set from the mains and therefore it must remain readily operable. If the TV set is not disconnected electrically from the mains, the device will still draw power for all situations even if the TV is in standby mode or switched off.

Note: Follow the on screen instructions for operating the related features.

IMPORTANT - Please read these instructions fully before installing or operating

⚠ WARNING: This device is intended to be used by persons (including children) who are capable / experienced of operating such a device unsupervised, unless they have been given supervision or instruction concerning the use of the device by a person responsible for their safety.

- Use this TV set at an altitude of less than 2000 meters above the sea level, in dry locations and in regions with moderate or tropical climates.
- The TV set is intended for household and similar general use but may also be used in public places.
- For ventilation purposes, leave at least 5cm of free space around the TV.
- The ventilation should not be impeded by covering or blocking the ventilation openings with items, such as newspapers, table-cloths, curtains, etc.
- The power cord plug should be easily accessible. **Do not** place the TV, furniture, etc. on the power cord. A damaged power cord/plug can cause fire or give you an electric shock. Handle the power cord by the plug, **do not** unplug the TV by pulling the power cord. Never touch the power cord/plug with wet hands as this could cause a short circuit or electric shock. Never make a knot in the power cord or tie it with other cords. When damaged it must be replaced, this should only be done by qualified personnel.
- Do not expose the TV to dripping or splashing of liquids and do not place objects filled with liquids, such as vases, cups, etc. on or over the TV (e.g., on shelves above the unit).
- Do not expose the TV to direct sunlight or do not place open flames such as lit candles on the top of or near the TV.





- Do not place any heat sources such as electric heaters, radiators, etc. near the TV set.
- Do not place the TV on the floor and inclined surfaces.
- To avoid danger of suffocation, keep plastic bags out of the reach of the babies, children and domestic animals.
- Carefully attach the stand to the TV. If the stand is provided with screws, tighten the screws firmly to prevent the TV from tilting. Do not over-tighten the screws and mount the stand rubbers properly.
- Do not dispose of the batteries in fire or with hazardous or flammable materials.

Warning: Batteries must not be exposed to excessive heat such as sunshine, fire or the like.

WARNING - excessive sound pressure from earphones or headphones can cause hearing loss.

ABOVE ALL - NEVER let anyone, especially children, push or hit the screen, push anything into holes, slots or any other openings in the case.

 Caution	Serious injury or death risk
 Risk of electric shock	Dangerous voltage risk
 Maintenance	Important maintenance component

Markings on the Product

The following symbols are used **on the product** as a marker for restrictions and precautions and safety instructions. Each explanation shall be considered where the product bears related marking only. Note such information for security reasons.

 **Class II Equipment:** This appliance is designed in such a way that it does not require a safety connection to electrical earth.

 **Hazardous Live Terminal:** The marked terminal(s) is/are hazardous live under normal operating conditions.

 **Caution, See Operating Instructions:** The marked area(s) contain(s) user replaceable coin or button cell batteries.

 **Class 1 Laser Product:** This product contains Class 1 laser source that is safe under reasonably foreseeable conditions of operation.

WARNING

Do not ingest the battery, Chemical Burn Hazard
This product or the accessories supplied with the product may contain a coin/button cell battery. If the coin/button cell battery is swallowed, it can cause severe internal burns in just 2 hours and can lead to death.

Keep new and used batteries away from children. If the battery compartment does not close securely, stop using the product and keep it away from children.

If you think batteries might have been swallowed or placed inside any part of the body, seek immediate medical attention.

Never place a television set in unstable or inclined locations. A television set may fall, causing serious personal injury or death. Many injuries, particularly to children, can be avoided by taking simple precautions such as;

- Using cabinets or stands recommended by the manufacturer of the television set.
- Only using furniture that can safely support the television set.
- Ensuring the television set is not overhanging the edge of the supporting furniture.
- Not placing the television set on tall furniture (for example, cupboards or bookcases) without anchoring both the furniture and the television set to a suitable support.
- Not standing the television set on cloth or other materials placed between the television and supporting furniture.
- Educating children about the dangers of climbing on furniture to reach the television set or its controls. If your existing television set is being retained and relocated, the same considerations as above should be applied.

Apparatus connected to the protective earthing of the building installation through the MAINS connection or through other apparatus with a connection to protective earthing – and to a television distribution system using coaxial cable, may in some circumstances create a fire hazard. Connection to a television distribution system has therefore to be provided through a device providing electrical isolation below a certain frequency range (galvanic isolator, see EN 60728-11)

Using the special functions to change the size of the displayed image (i.e. changing the height/width ratio) for the purposes of public display or commercial gain may infringe on copyright laws.

The LCD display panels are manufactured using an extremely high level of precision technology; however, sometimes some parts of the screen may be missing picture elements or have luminous spots. This is not a sign of a malfunction.

The set should be operated only from a 220-240 V AC 50 Hz outlet. Ensure that the television is not standing on the mains lead. Do not cut off the mains plug from this equipment, this incorporates a special Radio Interference Filter, the removal of which will impair its performance. It should only be replaced by a correctly rated and approved type. **IF IN DOUBT PLEASE CONSULT A COMPETENT ELECTRICIAN.**

WALL MOUNTING WARNINGS

- Read the instructions before mounting your TV on the wall.
- The wall mount kit is optional. You can obtain from your local dealer, if not supplied with your TV.
- Do not install the TV on a ceiling or on an inclined wall.
- Use the specified wall mounting screws and other accessories.
- Tighten the wall mounting screws firmly to prevent the TV from fall. Do not over-tighten the screws.

Specification is subject to change without notice.

Licenses

The terms HDMI and HDMI High-Definition Multimedia Interface, and the HDMI Logo are trademarks or registered trademarks of HDMI Licensing Administrator, Inc. in the United States and other countries.



Manufactured under license from Dolby Laboratories. Dolby Audio and the double-D symbol are trademarks of Dolby Laboratories.

Dolby Audio™ (supporting Dolby Digital Plus™)



For DTS patents, see <http://patents.dts.com>. Manufactured under license from DTS Licensing Limited. DTS, the Symbol, & DTS and the Symbol together are registered trademarks, and DTS TruSurround is a trademark of DTS, Inc.© DTS, Inc. All Rights Reserved.



For DTS patents, see <http://patents.dts.com>. Manufactured under license from DTS Licensing Limited. DTS, the Symbol, & DTS and the Symbol together are registered trademarks, and DTS 2.0+Digital Out is a trademark of DTS, Inc.© DTS, Inc. All Rights Reserved.



For DTS patents, see <http://patents.dts.com>. Manufactured under license from DTS Licensing Limited. DTS, DTS-HD, the Symbol, & DTS or DTS-HD and the Symbol together are registered trademarks of DTS, Inc.© DTS, Inc. All Rights Reserved.



DVB is a registered trademark of the DVB Project.

[1] EIA/CEA-861-D compliance covers the transmission of uncompressed digital video with high-bandwidth digital content protection, which is being standardized for reception of high-definition video signals. Because this is an evolving technology, it is possible that some devices may not operate properly with the television.

This product incorporates copyright protection technology that is protected by U.S. patents and other intellectual property rights. Use of this copyright protection technology must be authorized by Rovi Corporation, and is intended for home and other limited viewing uses only unless otherwise authorized by Rovi Corporation. Reverse engineering and disassembly are prohibited.

The "CI Plus" Logo is a trademark of CI Plus LLP.

Specification

TV Broadcasting	PAL BG/II/DK SECAM BG/DK
Receiving Channels	VHF (BAND I/III) - UHF (BAND U) - HYPERBAND
Digital Reception	Fully integrated digital terrestrial-cable-satellite TV(DVB-T-C-S) (DVB-T2, DVB-S2 compliant)
Number of Preset Channels	8,000
Channel Indicator	On Screen Display
RF Aerial Input	75 Ohm (unbalanced)
Operating Voltage	220-240V AC, 50Hz.
Audio	DTS TruSurround DTS 2.0+Digital Out DTS-HD
Audio Output Power (WRMS.) (10% THD)	2 x 8
Power Consumption (W)	75 W
Weight (Kg)	10.5
TV Dimensions DxLxH (with foot) (mm)	203 x 923 x 582
TV Dimensions DxLxH (without foot) (mm)	90 x 923 x 547
Display	16:9 40"
Operation temperature and operation humidity	0°C up to 40°C, 85% humidity max

Disposal...

The following information is only for EU-member states:

Disposal of products

The crossed out wheeled dust bin symbol indicates that products must be collected and disposed of separately from household waste. Integrated batteries and accumulators can be disposed of with the product. They will be separated at the recycling centres.



The black bar indicates that the product was placed on the market after August 13, 2005.

By participating in separate collection of products and batteries, you will help to assure the proper disposal of products and batteries and thus help to prevent potential negative consequences for the environment and human health.

For more detailed information about the collection and recycling programmes available in your country, please contact your local city office or the shop where you purchased the product.

Disposal of batteries and/or accumulators

The crossed out wheeled dust bin symbol indicates that batteries and/or accumulators must be collected and disposed of separately from household waste.



If the battery or accumulator contains more than the specified values of lead (Pb), mercury (Hg), and/or cadmium (Cd) defined in the European Battery Directive, then the chemical symbols for lead (Pb), mercury (Hg) and/or cadmium (Cd) will appear below the crossed out wheeled dust bin symbol.

By participating in separate collection of batteries, you will help to assure the proper disposal of products and batteries and thus help to prevent potential negative consequences for the environment and human health. For more detailed information about the collection and recycling programmes available in your country, please contact your local city office or the shop where you purchased the product.

REACH information

The European Union (EU) chemical regulation, REACH (Registration, Evaluation, Authorization and Restriction of Chemicals), entered into force on 1 June 2007, with phased deadlines to 2018.

Toshiba will meet all REACH requirements and is committed to provide our customers with information about the presence in our articles of substances included on the candidate list according to REACH regulation.

Please consult the following website www.toshiba-tv.com for information about the presence in our articles of substances included on the candidate list according to REACH in a concentration above 0.1 % weight by weight.

EU Conformity Statement



This product is carrying the CE-Mark in accordance with the related European Directives.

Responsible for CE-Marking is Vestel UK, Langley, Berkshire, SL3 6EZ.

This product is labelled with the CE Mark in accordance with the related European Directives, notably RoHS Directive 2011/65/EU. Furthermore the product complies with the Ecodesign Directive 2005/32/EC (EuP) and 2009/125/EC (ErP) and its related implementing measures.

This equipment corresponds to requirements of the Technical Regulation on limitation of usage of certain dangerous substances in electrical and electronic equipment.

Hereby, VESTEL Elektronik Sanayi ve Ticaret A.Ş., declares that the radio equipment type TV is in compliance with Directive 2014/53/EU. The full text of the EU declaration of conformity is available at the following internet address: doc.vosshub.com

Find out all you need to know about the latest, trend-setting TV technology on our website.

www.toshiba-tv.com

You can review your TV user manual online or download as you like



Product Fiche		
Commercial Brand: TOSHIBA		
Model No.	40L1863DB	
Energy efficiency class	A+	
Visible screen size (diagonal, approx.) (inch/cm)	40 inches	102 cm
On mode average power consumption (Watt)	46.0 W	
Annual energy consumption (kWh/annum)(*)	67.0 kWh	
Standby power consumption (Watt)	0.50 W	
Off mode power consumption (Watt)	N/A	
Display resolution (px)	1920x1080	

(*)Energy consumption kWh per year, based on the power consumption of the television operating 4 hours per day for 365 days. The actual energy consumption will depend on how the television is used.

VESA WALL MOUNT MEASUREMENTS			
A			
B	Hole Pattern Sizes (mm)	W	H
		200	200
C	Screw Sizes		
D	Length (X)	min. (mm)	10
		max. (mm)	13
E	Thread (Y)	M6	

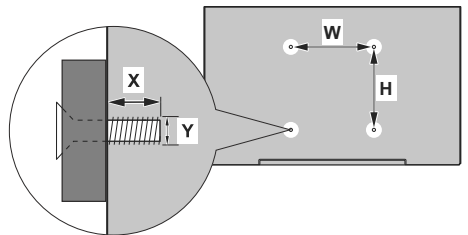

	A	B	C	D	E
English	VESA WALL MOUNT MEASUREMENTS	Hole Pattern Sizes (mm)	Screw Sizes	Length (X)	Thread (Y)
Deutsch	MASSANGABEN FÜR VESA-WANDMONTAGE	Lochmustergrößen (mm)	Schraubengrößen	Länge (X)	Gewinde (Y)
Français	DIMENSIONS DU SUPPORT DE FIXATION MURALE VESA	Dimensions des modèles de trous de montage (mm)	Dimensions des vis	Longueur (X)	Filetage (Y)
Italiano	Misurazioni installazione a parete VESA	Dimensioni schema foro (mm)	Dimensioni vite	Lunghezza (X)	Filettatura (Y)
Português	MEDIÇÕES DE MONTAGEM MURAL VESA	Dimensões do molde de furação (mm)	Tamanhos do parafuso	Comprimento (X)	Rosca (Y)
Español	MEDIDAS DEL MONTAJE DE PARED VESA	Tamaños de patrón para agujero (mm)	Tamaños de tornillo	Longitud (X)	Rosca (Y)
Türkçe	VESA DUVARA MONTAJ ARAÇI ÖLÇÜLERİ	Açılacak Delik Ölçüleri (mm)	Vida Ölçüleri	Uzunluk (X)	Yüzey (Y)
Ελληνικ	ΔΙΑΣΤΑΣΕΙΣ ΒΑΣΗΣ ΤΟΙΧΟΥ VESA	Μεγέθη ορυχμάτων οτάν (mm)	Μεγέθη βιδών	Μήκος (X)	Ξελίρωμα (Y)
Polski	WYMIARY DO MONTAŻU NA ŚCIANIE VESA	Rozmiary szablonu otworów (mm)	Rozmiary wkrętów	Długość (X)	Gwint (Y)
Čeština	ROZMĚRY DRŽÁKU NA ZĚB VESA	Rozměry velikosti děr (mm)	Rozměry šroubů	Délka (X)	Závit (Y)
Magyar	VESA FALI TARTÓ MÉRTEK	Lyukak méretének nagyságát (mm)	Csavar méret	Hossz (X)	Menet (Y)
Română	MĂSĂTORI SUPORT PERETE VESA	Dimensiuni tipar gaură (mm)	Dimensiuni suruburi	Lungime (X)	Filet (Y)
Svenska	VESA VÄGGMONTERINGSMÅTT	Hålmonsterstorlekar (mm)	Skrueforlekar	Längd (X)	Tråd (Y)
Nederlands	VESA WANDMONTAGE METINGEN	Grootte booropening (mm)	Schroefgrootte	Lengte (X)	Draad (Y)
Suomi	VESA-SEINÄASENNUKSEN MITAT	Reikäkuivon koot (mm)	Ruuvinkoot	Pituus (x)	Kierre (Y)
Norsk	VESA VEGGMONTERINGSMÅL	Hullmønster størrelser (mm)	Skruestørrelser	Lengde (x)	Tråd (Y)
Dansk	VESA VÆGMONTERINGSMÅL	Hulmønster-størrelser (mm)	Skruestørrelser	Længde(x)	Tråd (Y)
Русский	РАЗМЕРЫ НАСТЕННОГО КРЕПЛЕНИЯ VESA	Размеры системы отверстий	Размеры винтов	Длина(х)	Резьба (Y)
Българска	ПАМЕРИ НА СТЕННАТА МАЦАВАННА VESA	Памери системи адтулин	Памери винтоџ	Дължина (X)	Резьба (Y)
македонски	МЕРКИ ЗА МОНТИРАЊЕ НА СИД ЗА „VESA“	Шема на големини на дупката (mm)	Големина на шрафот	Должина (X)	Навој (Y)
українська	РОЗМІРИ НАСТІННОГО КРЕПЛЕННЯ VESA	Відстань між кріпильними отворами, мм	Толщина гвинтів	Довжина (X)	Діаметр різьби (Y)
Srpski	DIMENZJE VESA ZIDNOG NOSAČA	Dimenzije šablona za bušenje	Dimenzije zavrtanjeva	Dužina (X)	Navoj (Y)
Slovenčina	ROZMERY DRŽIAKA NA STENU VESA	Rozmery veľkosti dier (mm)	Dimenzije skrutiek	Dĺžka (X)	Závit (Y)
Slovensčina	MERE STENSKEGA NOSILCA VESA	Velikosti vzorca lukeni (mm)	Velikosti vijakov	Dožina (X)	Navoj (Y)
Hrvatski	VESA MJERE ZIDNOG DRŽAČA	Većičine uzorka otvora (mm)	Većičine vijaka	Dužina (X)	Navoj (Y)
Bosanski	DIMENZIJE VESA ZIDNOG NOSAČA	Dimenzije šablona za bušenje	Dimenzije vijaka	Dužina (X)	Navoj (Y)
Български	РАЗМЕРИ ЗА КОМПЛЕКТ ЗА МОНТАЖ НА СТЕНА VESA	Размери на отвора (mm)	Размер на болта	Дължина(х)	Резьба (Y)
Lietuvių	VESA TVIRTINIMO PRIE SIENOS MATAVIMAI	Angos šablono dydis (mm)	Varžtų dydis	Ilgis (X)	Sriegis (Y)
Latviešu	VESA SIENAS STIPRINĀJUMA IZMĒRI	Saurumu šablona izmērs (mm)	Skrūvju izmēri	Garums (X)	Vītnes (Y)
Eesti	VESA SEINALE KINNITAMISE MÕÕDUD	Kruvi suuruse mõõt (mm)	Kruvi suurus	Xõrgus(x)	Käär (Y)
Shqip	PËRMASAT E NJËSË SË MONTIMIT NË MUR VESA	Madhësitë modele të vrimave (mm)	Madhësitë e vidhave	Gjatësia (X)	Filetimi (Y)
عربي	مقاييس VESA للتثبيت على الجدار	أحجام الثقوب (مم)	أحجام البرغي	الطول (X)	السنن (Y)
בדברי	מדידות מודל של הקיר VESA	גודל חבדות החדים (mm)	גודל הבדנים	(X) ערוך	חביר (Y)
فارسی	اندازه گیری اتصال دیواری VESA	اندازه های سوراخ (میل برتر)	اندازه های پیچ	طول (X)	رشته (Y)

TOSHIBA



50451962